

Data Sheet



Article number: 2307083752

Description: E+G Direct drive position indikator
DD52R-FR-0005.0-S-C3 (Grey)

Measures

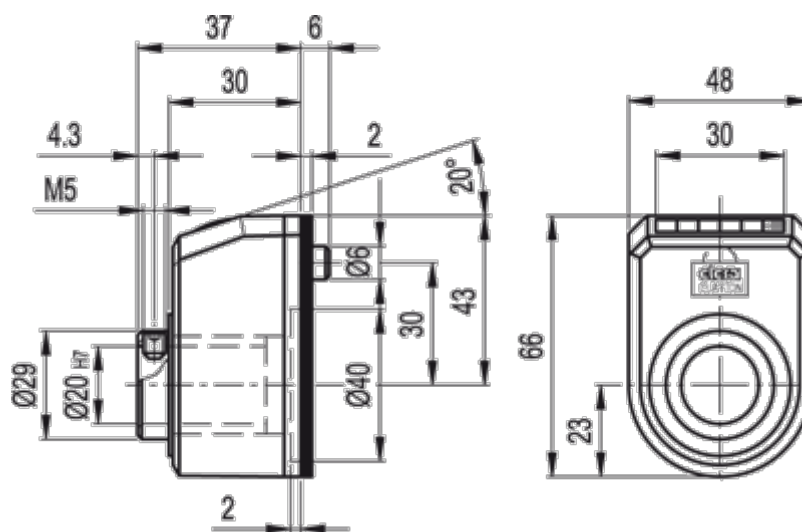

Max rpm = 500